



DE Aufbauanleitung Komposter „MonAmi®“

- Ⓒ GB Assembly manual for Composter “MonAmi®”
- Ⓒ FR Notice de montage du Composteur “MonAmi®”
- Ⓒ NL Opbouwbeschrijving voor CompostBox “MonAmi®”
- Ⓒ ES Instrucciones de montaje de Compost “MonAmi®”
- Ⓒ IT Istruzioni di montaggio Compostiera “MonAmi®”
- Ⓒ DK Monteringsvejledning for Kompostbeholder “MonAmi®”



 Poišćite vař prevod na ...

 Najděte svůj překlad ...

 Hitta din översättning ...

 Finn din oversettelse ...

 Találja meg fordítását ...



Wichtige Punkte für den Aufbau!

Vorliegende Aufbauanleitung zeigt den Zusammenbau für einen Komposter „MonAmi“. Für einige Montageschritte benötigen Sie einen Helfer.

- GB *Important details regarding assembly! The available assembly manual shows the installation of the composter “MonAmi”. For several assembly steps additional assistance of one person will be required.*
- FR *Points importants lors du montage! „Cette notice de montage décrit l’assemblage du composteur “MonAmi”. Pour certaines étapes, demandez l’aide d’une ou deux personnes.*
- NL *Deze opbouwbeschrijving toont de opbouw van de compostbak “MonAmi”. Bij enkele stappen tijdens de opbouw heeft u een 2e persoon nodig.*
- ES *Notas importantes para el montaje: Estas instrucciones de montaje muestran el ensamblaje de un compostador “MonAmi”. Es recomendable realizar el montaje entre dos personas.*
- IT *La presente istruzione di montaggio dimostra il montaggio di una compostiera “MonAmi” . Per alcune fasi di assemblaggio vi servirà qualche aiutante.*
- DK *Denne vejledning viser samling af kompostbeholder “MonAmi”. Ved flere punkter af opsætningen er yderligere hjælp påkrævet af 1 eller 2 personer.*



Um Kratzer zu vermeiden, verwenden Sie bitte geeignete Unterlagen!

- GB *Please use a suitable underlay to avoid scratches!*
- FR *Pour éviter les rayures, utilisez les supports appropriés!*
- NL *Om krassen te voorkomen raden wij u aan er iets onder te leggen!*
- ES *Por favor, coloque en el suelo una base protectora adecuada para evitar posibles arañazos.*
- IT *Utilizzare una base adatta per evitare graffi!*
- DK *Benyt venligst et passende underlag for at undgå skrammer!*



Wasserwaagen - Symbol:

Betreffendes Einbauteil mit der Wasserwaage ausrichten.

- GB *Symbol of spirit level: Align the respective parts by using the spirit level.*
- FR *Symbole niveau à bulle: Lorsque ce symbole apparaît, vous devez ajuster l’élément à l’aide d’un niveau à bulle.*
- NL *Waterpas - symbool: Bij montageschappen waar dit symbool bijstaat is het noodzakelijk het betreffende onderdeel waterpas in te bouwen.*
- ES *Símbolo del nivelador: Indica que se debe ajustar y centrar la pieza con la ayuda de un nivelador.*
- IT *Simbolo di livella a bolla d’aria: Allineare il componente in questione con l’ausilio di una livella a bolla d’aria.*
- DK *Symbol for vaterpas: Juster de respektive dele ved hjælp af vaterpas.*

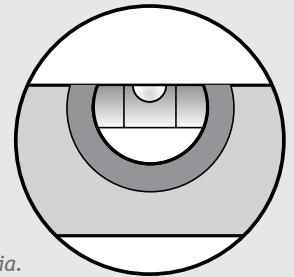

Verwenden Sie bei der Montage Arbeitshandschuhe!

- GB *Wear working gloves!*
- FR *Portez des gants de travail*
- NL *Handschoenen gebruiken!*
- ES *Utilice unos guantes de trabajo.*
- IT *Utilizzare guanti da lavoro*
- DK *Brug arbejdshandsker!*



Maßstabsgetreue Abbildungen der zu verwendenden Schrauben:

- GB *Scale drawing 1:1 of the screws in use*
- FR *Reproduction selon l’échelle 1:1.*
- NL *Afbeelding : schaal 1:1 (ware grootte)*
- ES *Reproducción a escala 1:1 de los tornillos que se utilizan para el montaje.*
- IT *Riproduzione in scala 1:1 delle viti da utilizzare.*
- DK *Skala tegning af skruer er 1:1*

M 1:1

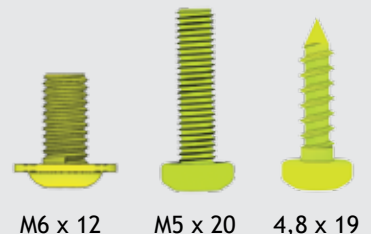

M6 x 12

M5 x 20

4,8 x 19

Pflege und Wartung

- Keine aggressiven Chemikalien wie z.B. Chlor oder Streusalz lagern!
- Sonnenmilch und andere Cremes mit Wasser und Seife entfernen
- Keine scheuernden Reinigungsmittel verwenden!

(NL) Onderhoud

- Geen chemicaliën in de Moestuinbox!
- Zonnebrandolie/melk en andere cremes met water en zeep verwijderen!
- Gebruik geen schuurmiddelen!

(DK) Pleje og vedligeholdelse

- Opbevar ikke aggressive stoffer dvs. Klor eller vejsalt!
- Fjern solcreme eller andre typer af creme med vand og rensmiddel!
- Brug ikke aggressive rengøringsmidler!

(GB) Care and maintenance

- Do not store aggressive substances i.e. chlorine or road salt
- Remove suntan lotion or any other creams with water and soap!
- Do not use abrasive cleaning agents!

(ES) Cuidado y mantenimiento

- No almacene productos químicos agresivos dentro del Huerto Urbano, como por ejemplo cloro y sal antiescarcha.
- Evite dejar huellas o restos de cremas solares sobre la chapa. Limpie al arcón siempre con agua o un trapo húmedo.
- No utilice ningún producto para fregar. En general, evite siempre cualquier producto químico para limpiar al arcón.

(FR) Entretien et maintenance

- Ne pas stocker de produits chimiques (chlore, sel, etc...)
- Nettoyez les traces de crème solaire ou autre uniquement avec de l'eau et du savon
- Ne pas utiliser de produits nettoyant abrasifs!

(IT) Manutenzione

- Non lasciare prodotti chimici aggressivi (come ad esempio cloro o sale per strade) all'interno della Aiuola rialzata!
- Rimuovere crema solare e altre creme con acqua e brillantante!
- Non utilizzare detergenti contenenti sostanze aggressive!

Teileübersicht

parts list · liste des pièces · stuklijst · lista de piezas · lista de parti · deloversigt

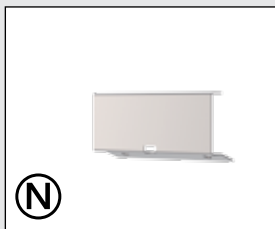
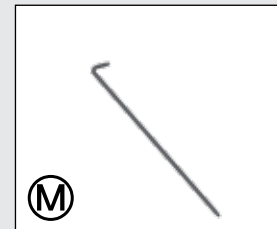
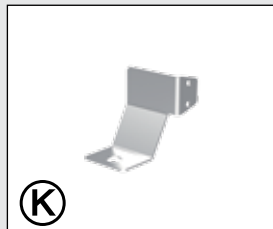
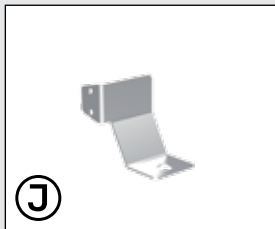
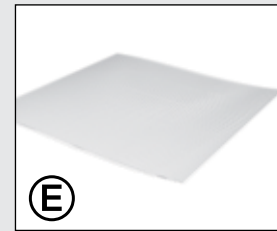
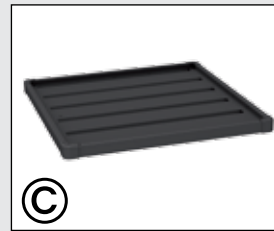
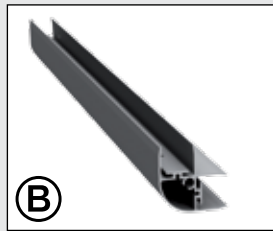
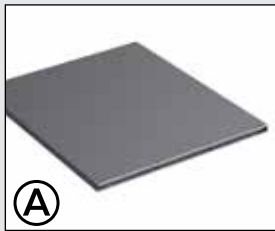

1.

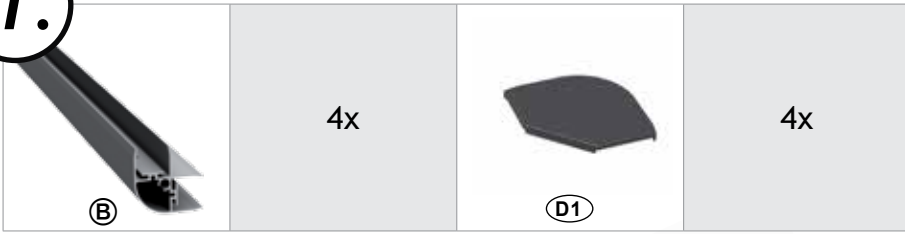

2.

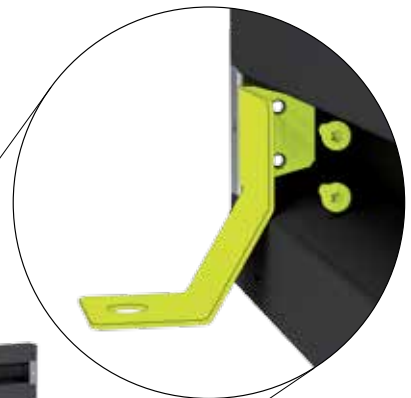
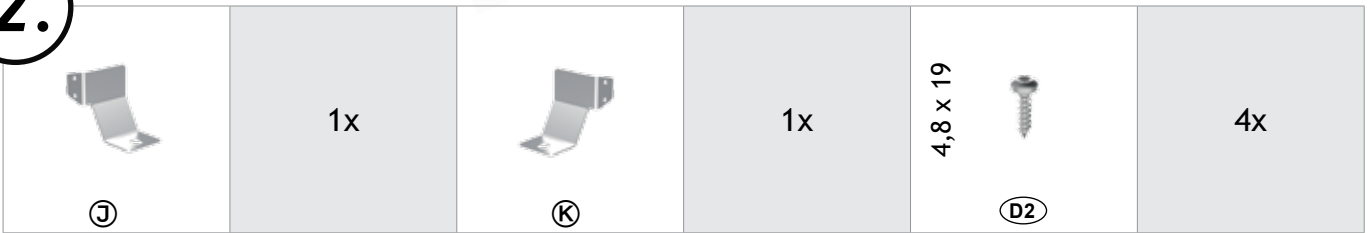

3.

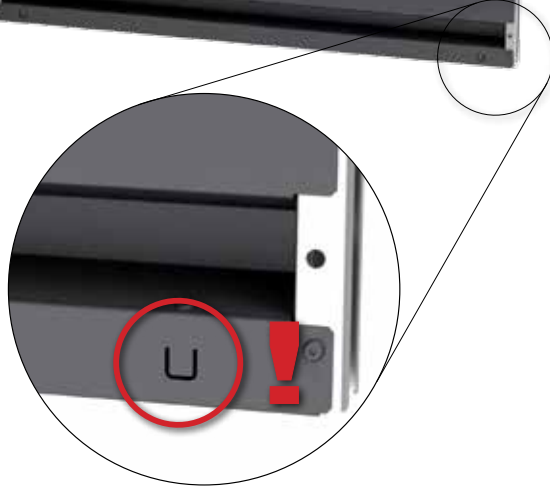
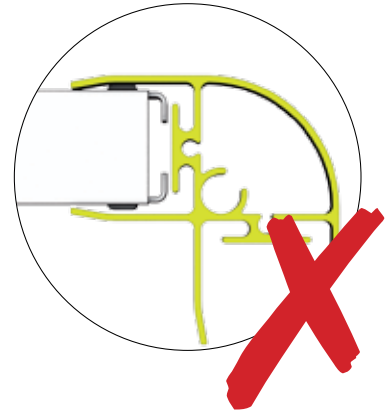
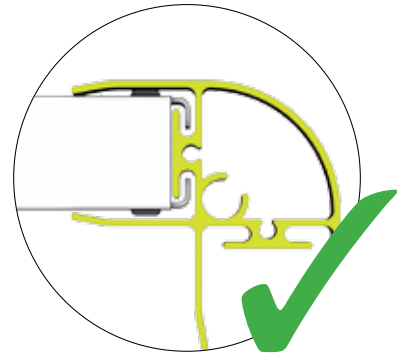
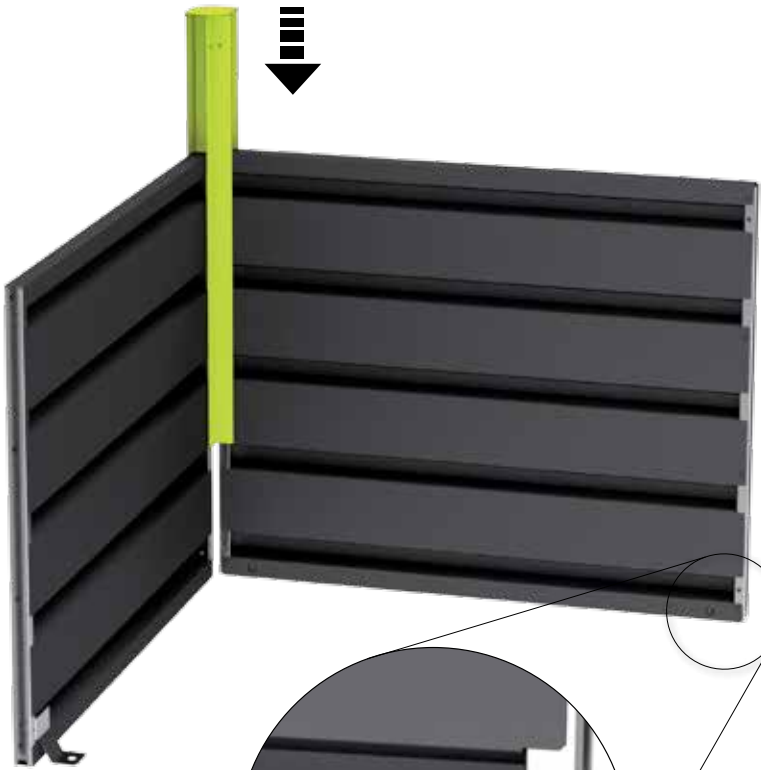

4.

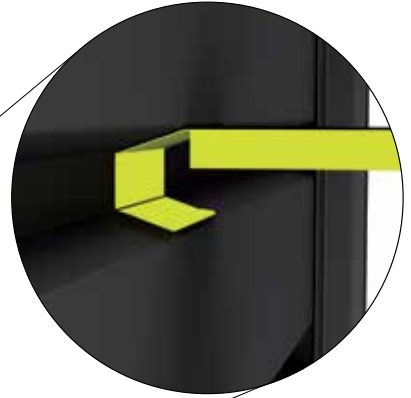
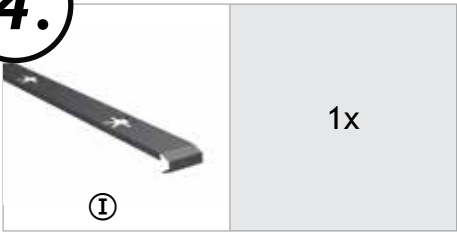

Option:



5.

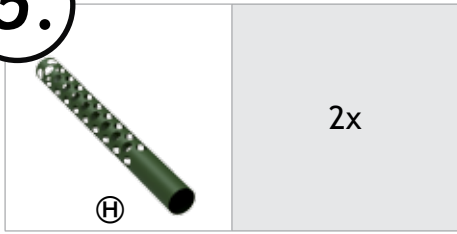

6.

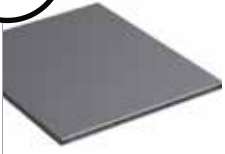

1x

4,8 x 19



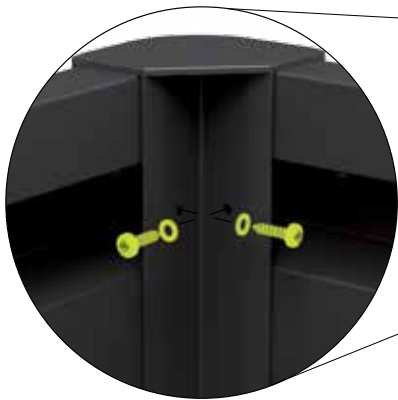

8x

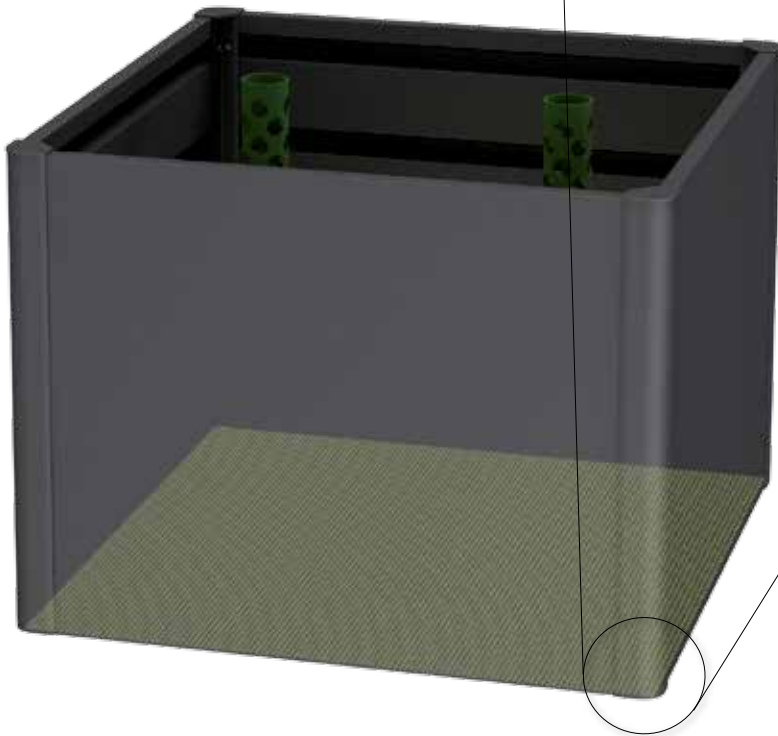
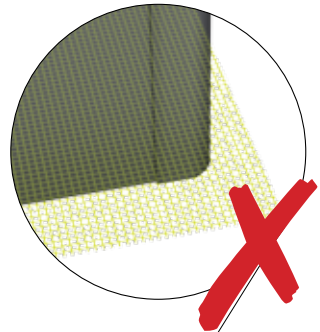
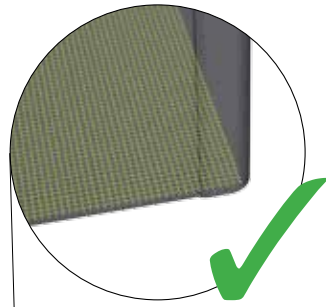
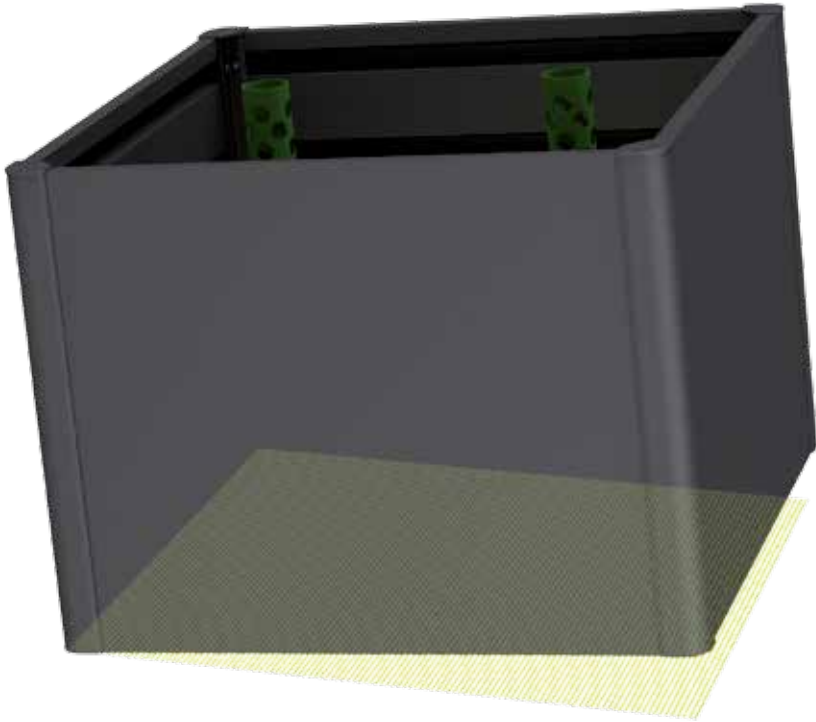
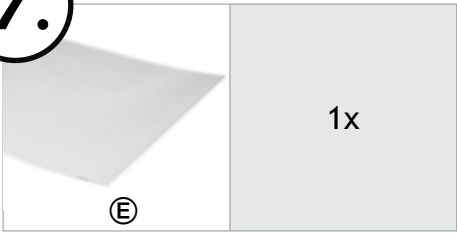

7.







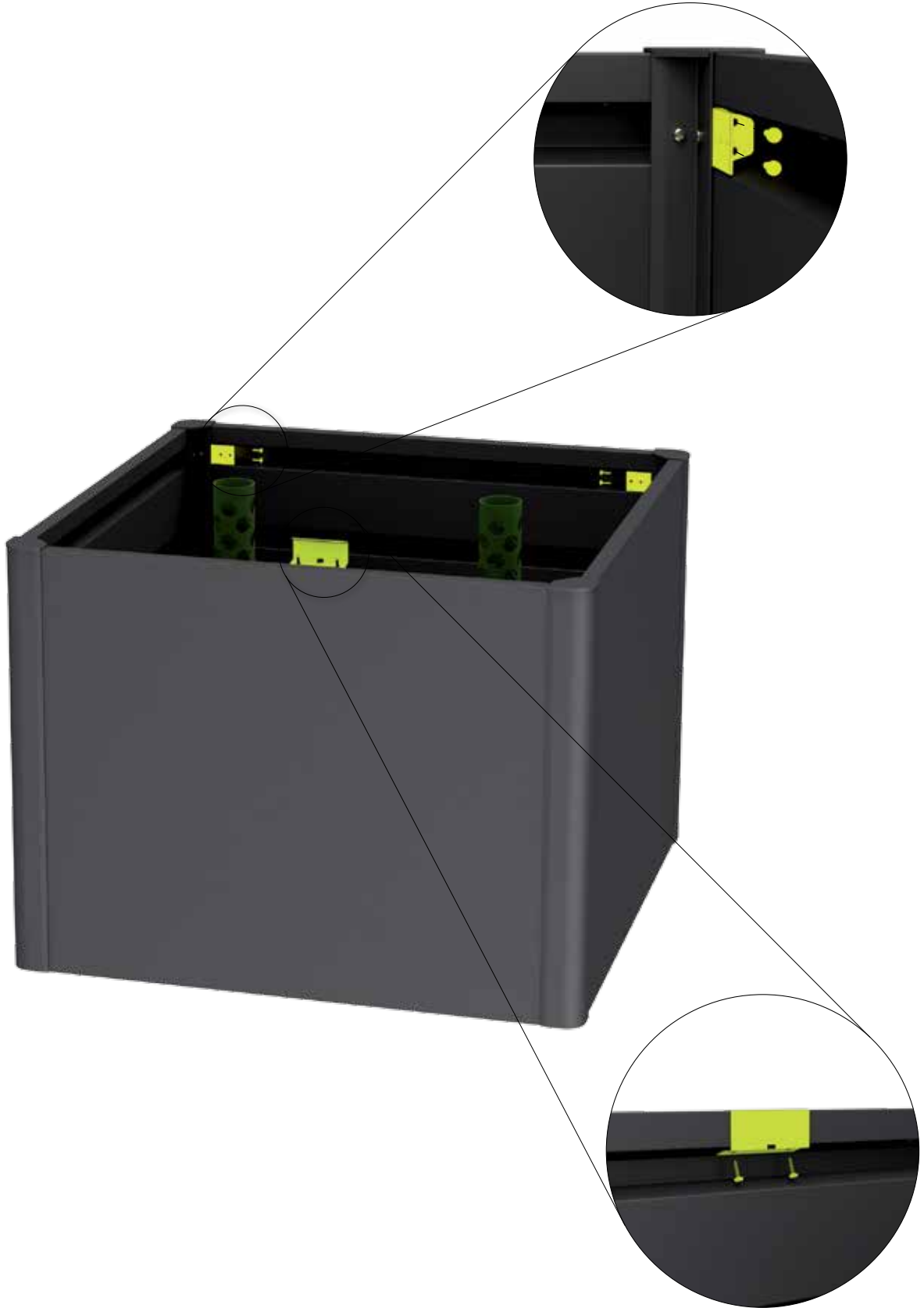

8.

 D2	2x	4,8 x 19  D2	6x	 N	1x
---	----	---	----	--	----





9.

 ©	1x	 F	1x	 G	1x
M6 x 12  D2	4x	 O	1x	 D2	2x
M5 x 20  D2	2x				



10.

 D2	4x	 D2	2x	 L	2x
---	----	---	----	--	----

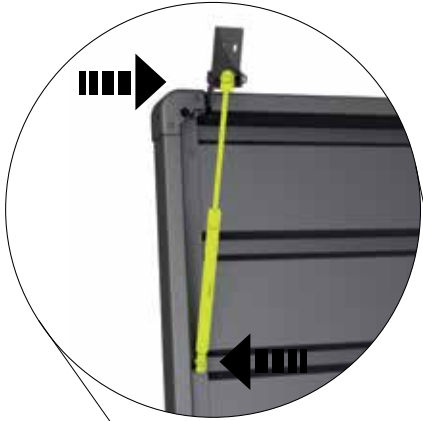
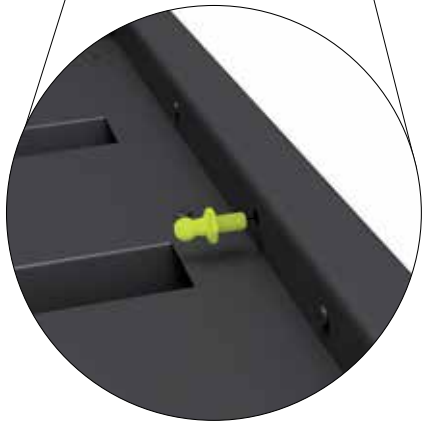

11.

M6 x 12



D2

4x



12.

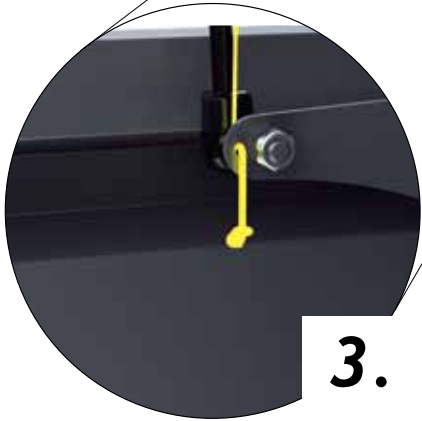
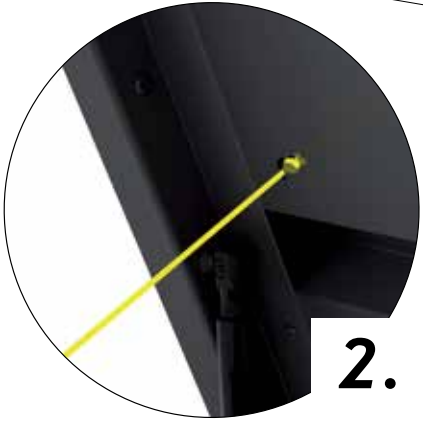
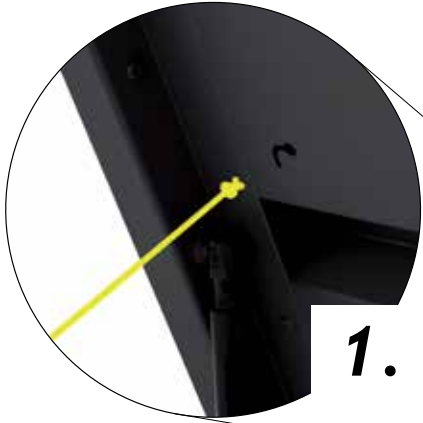
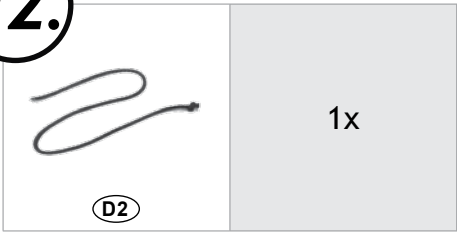

13.

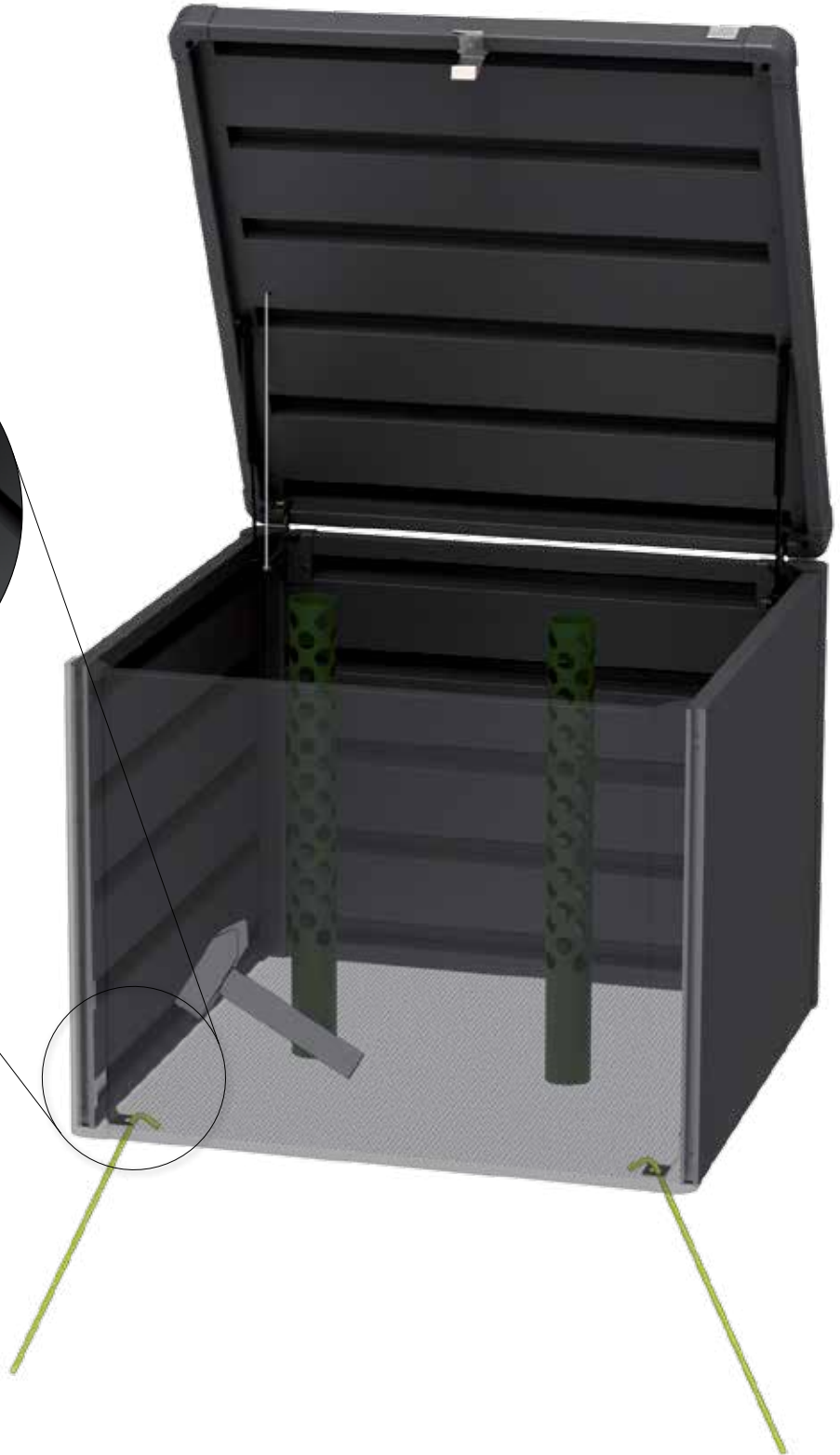
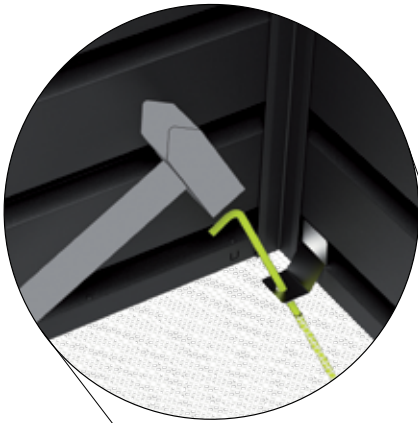
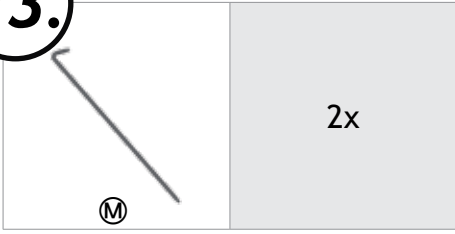



Gerätehäuser

Setzen Sie auf
Qualität & Langlebigkeit



Gartenboxen

Outdoorboxen für
Garten, Terrasse & Co



Fahrrad-Garagen

Fahrräder, Roller & Co sicher
verstaut



Mülltonnen-Boxen

Stylisch, praktisch
und wartungsfrei



Brennholzlager

Kaminholzlager und Geräte-
schrank in einem



Pflanzgefäße und Garten-Helfer

Gartendesign
in Bestform

Kontrollnummer:
Control-number / Contrôle-Qualité / Controlnummer:



Bei Reklamationen bitte anführen:
Kontrollnummer und Artikelnummer des reklamierten Teils.

GB: In case of complaint please indicate the control-number and the number of the item, which is subject of complaint.

F: Pour toutes réclamations: prière de joindre le numéro de contrôle et le numéro d'article de la pièce litigieuse.

NL: Bij reclamaties svp doorgeven: controlnummer en artikelnummer van het desbetreffende onderdeel.